







split@Solution

Every EdenGarden Heavy Duty Patio Umbrella is produced with a lifted valve, a small frame on top of the canopy that provides better resistance to sudden gusts of wind. In windy areas it is possible to apply the SPLIT @ SOLUTION construction technique for larger models (4x4m and above). The SPLIT @ SOLUTION is a patented anti-wind system with six overlapping fabrics strips that help put an end to the 'sail effect' caused by wind against the canopy. The waterproof characteristics of the fabric of the umbrella remain but improved air circulation enhances the chill sensation during hot summer days. The sophisticated design gives the exclusive EdenGarden umbrellas a refined look and enhances their primary function as an essential accessory for the best outdoor spaces.

Ogni ombrellone EdenGarden nasce di serie con una valvola rialzata, utile per contrastare le folate di vento improvvise. Per aree ventose e specialmente per ombrelloni grandi (dal 4x4 in su), come optional è possibile scegliere gli ombrelloni con SPLIT@ SOLUTION, un sistema brevettato di supporto con strisce di tessuto sovrapposte. Il sistema SPLIT@ SOLUTION offre una rilevante attenuazione dell' "effetto vela" che il vento esercita sull'ombrellone, senza compromettere l'impermeabilità della copertura. Nei caldi mesi estivi Split Solution assicura maggiore traspirazione dell'aria sottostante.

Il design sofisticato è un valore aggiunto che caratterizza i prodotti EdenGarden come accessori essenziali per i migliori spazi outdoor.

Svaki EdenGarden suncobran se rađa sa uzdignutim ventilom koji pojačava otpornost na iznenadne nalete vjetera. Za jako vjetrovite zone, osobito kad se instaliraju veliki suncobrani (4x4m i više), savjetujemo korišćenje SPLIT @ SOLUTION sistema. SPLIT @ SOLUTION je naša patentovana tehnika konstrukcije anti-vjetar suncobrana čijih 6 odvojenih traka platna pomažu u zaustavljanju "efekta jedra" na površini suncobrana. Nepromočivost naših modela ostaje nepromijenjena, dok cirkulacija vazduha olakšava uživanje u Vašoj bašti tokom vrelih ljetnjih dana.

Sofisticirani dizajn daje prefinjeni izgled ekskluzivnim EdenGarden suncobranima i pretvara ih u nezamjenjiv dodatak Vašim outdoor prostorima.





Quality

The quality of EdenGarden workmanship, sustained over thirty years of experience and numerous patents, allows us to offer a two-year guarantee for all of our product components, if used in compliance with the Instructions for Use. EdenGarden only proposes the best EU outdoor fabrics. Our Umbrellas can be crafted in Acrylic (100%) outdoor fabric (300gr/sq. m), Teflon treated (10 year warranty) or PVC Preconstraint 302 or 502 by Ferrari (100% waterproof, pre-tensioned). It is also possible to choose Soltis, a modern micro aired fabric, as an option. Please consult our Color Samples for more information on the range of fabrics we offer.

La qualità di lavorazione EdenGarden, sostenuta da un'esperienza trentennale e molteplici brevetti conseguiti, ci consente di offrire una garanzia di 2 anni su tutti i componenti dei nostri prodotti, se usati rispettando il Manuale di Manutenzione allegato. EdenGarden propone solo i migliori tessuti per esterni prodotti in Europa. Di serie offriamo la scelta tra. Tessuto Acrilico 300 g/mq, 100% acrilico outdoor, trattato al teflon, con 10 anni di garanzia. PVC preconstraint Ferrari 302 e 502 100% impermeabile, pretensionato. Come optional è possibile scegliere il moderno Soltis Air microforato. Vi invitiamo a consultare la nostra Mazzetta Colori per avere maggiori informazioni sulla gamma proposta.

Kvalitet EdenGarden suncobrana je rezultat trideset godina iskustva i brojnih patenata. Svi naši proizvodi imaju garanciju od 2 godine, naravno uz poštovanje Priručnika za korišćenje koji prati svaki naš proizvod! Platna u našoj ponudi su outdoor platna najboljih EU proizvođača. Svaki suncobran može biti izrađen u: 100% Akrilno Outdoor platno, 300gr/kvm, tretirano teflonom, 10 godina garancije, ili PVC Preconstraint by Ferrari, 302 ili 502, 100% nepromociv, pre-tensioniran. Moguće je naruciti kao dodatak I moderno mikro-izbuseno platno Soltis Air Ferrari. Za dodatne informacije I tehnicke karakteristike mozete konsultovati nasu Kartu Boja.





Workmanship

EdenGarden bases are constructed of reinforced concrete finished with river grit. Alternatively, we can also develop plates for underground installation, wall-mounted brackets and other customized solutions. We use 'iroko' wood for the strong load bearing beams, which is the most suitable and durable wood for outdoor use. As an alternative, we also offer furnace painted steel or mirror polished stainless steel. The ribs can be made of solid wood (for canopies up to 4x4 m) or from reinforced and furnace painted aluminum. Stainless steel bolts anchor each umbrella's frame rib in order to ensure maximum strength and facilitate eventual substitution. All steel components are zinc plated before being furnace painted in the desired color.

I basamenti EdenGarden sono realizzati in cemento armato e rifiniti con graniglia di fiume. In alternativa è possibile realizzare piastre da interrare, oppure staffe a muro e altre soluzioni personalizzate. Per i robusti travi portanti utilizziamo il legno "iroko", il più adatto e durevole per l'uso esterno, offrendo come alternativa l'acciaio verniciato a forno oppure inox lucidato a specchio. Le stecche possono essere realizzate in legno "frassino americano" (per capote fino a 4x4m) oppure in alluminio rinforzato e verniciato a forno. Ogni stecca è ancorata con un bulone e dado in acciaio INOX, in modo da garantire massima resistenza e facilità di sostituzione qualora serva. Tutti i componenti in acciaio vengono zincati prima di essere verniciati a forno nel colore desiderato, in modo da proteggerli dalla ruggine e dagli agenti atmosferici.

Svi naši suncobrani imaju betonsko postolje, a po želji radimo i ploče za ukopavanje u beton, zidne nosače, a moguće je su i personalizirane solucije. Za čvrste nosače naših bočnih suncobrana nudimo isključivo IROKO drvo afričkog porijekla, odlikovano kako iskazanom robusnosti i trajnosti tako i neodoljivom estetskom privlačnošću. Nudimo takođe na istim modelima mogućnost izrade nosećeg stuba od željeznog profila, cinčanog i plastificiranog u željenoj boji. Steke (letve) suncobrana su izrađene ili od pojačanog aluminijskog profila ili od američkog hrasta. Aluminijske letve moguće je, po narudžbi, farbati u željenoj boji. Svaka letva koja nosi platno je pričvršćena saračima od nehrđajućeg celika da bi osigurali maksimalnu izdržljivost i omogućili laku zamjenu. Svi željezni komponenti su cinčani i plastificirani u peći u željenoj boji. Baze mogu biti cementne, željezne, pričvršćene za tlo ili zid.





Customization

Every EdenGarden patio umbrella is hand crafted on request and therefore it is possible to customize every single component of our exclusive patio umbrellas. On request, we can construct triangular, trapezoidal, special dimension umbrellas and many other customized solutions! Our 30 years of experience combined with modern 3D projection service are at your disposal to follow your desires and needs and to create a unique umbrella for your garden! Our aim to offer the widest range of outdoor umbrellas has led us to our new stainless steel line of umbrellas. These umbrellas are created to withstand the challenges of usage on the open sea and are intended for yachts and super yachts. The stainless steel line of umbrellas is crafted entirely in mirror polished AISI 316 stainless steel. This year we also introduced the new double layer Split Solution umbrellas. Double fabric strips enhance the sensation of freshness and open up new design frontiers for our exclusive Heavy Duty Patio Umbrellas.

Ogni ombrellone EdenGarden viene realizzato su richiesta, ed è possibile personalizzare ogni componente del Vostro ombrellone. Possiamo realizzare ombrelloni triangolari, trapezoidali, dimensioni particolari e tante altre soluzioni su misura. Il nostro studio di progettazione mette a disposizione i nostri 30 anni di esperienza e le più moderne tecniche di progettazione 3D per realizzare l'ombrellone che fa al caso Vostro! Dal desiderio di offrire una gamma completa di ombrelloni nasce anche la linea Stainless Steel. Sono gli ombrelloni realizzati per resistere alle sfide del mare aperto, progettati per yachts e superyachts, e realizzati tutti in acciaio AISI 316 lucidato a specchio. Da quest'anno inoltre abbiamo in offerta anche gli ombrelloni Split Solution creati con il doppio tessuto, in modo da offrire una nuova sensazione di freschezza e aprire nuove frontiere di design per i nostri Grandi Ombrelloni da Giardino.

Svaki EdenGarden suncobran se radi po narudžbi i moguće je personalizirati svaki detalj naših modela. Po želji pravimo trokutaste, trapezoidalne, suncobrane posebnih dimenzija i mnoga druga personalizirana rješenja. EdenGarden stavlja na raspolaganje 30 godina iskustva zajedno sa modernim 3D projektnim uredom, kako bi pratili svaku Vašu želju i potrebu, i napravili jedinstveni suncobran za Vašu baštu. Naša želja da ponudimo najširi spektar baštenskih suncobrana dovela nas je do nove linije Stainless Steel suncobrana. Ovi suncobrani su napravljeni da izdrže izazove korištenja na otvorenom moru i projektovani su za montažu na jahte i superjahte. Cijela konstrukcija je izrađena od ispoliranog AISI 316 nehrđajućeg čelika. Od ove godine također su u ponudi i suncobrani Split Solution sa duplim platnom, koje povećava osjećaj svježine u toplim ljetnjim mjesecima i otvara nove granice za dizajn naših ekskluzivnih velikih baštenskih suncobrana.





FIESOLE • BIG FRIEND • KITE • CIAK

Ombrelloni a Palo Centrale
Central Pole Patio Umbrellas
Centralni suncobrani



central

et



Fiesole

If you are looking for a traditional aesthetically refined model that is still practical and durable then the Fiesole umbrella is your ideal solution. The lifted valve offers protection from sudden gusts of wind and creates its signature linear form. It is available in supported valve, lifted valve or Split Solution versions.

Fiesole rappresenta la soluzione ideale per chi cerca un'ombrellone tradizionale esteticamente raffinato e al tempo stesso pratico e robusto, anche da inserire come cornice ad altri ombrelloni di grandi dimensioni. Viene fornito nella versione con valvola appoggiata, rialzata, o Split Solution.

Ako tražite tradicionalni, estetski rafiniran suncobran koji je praktičan i trajan, Fiesole je najbolje rješenje za Vas! Takođe možete koristiti Fiesole kao okvir i upotpunjene za već postojeća rješenja sa našim Velikim Suncobranima. Moguće je praviti Fiesole Suncobran sa spuštanim ventilom, uzdignutim ventilom i sa našim ekskluzivnim vjetrootpornim rješenjem Split Solution.

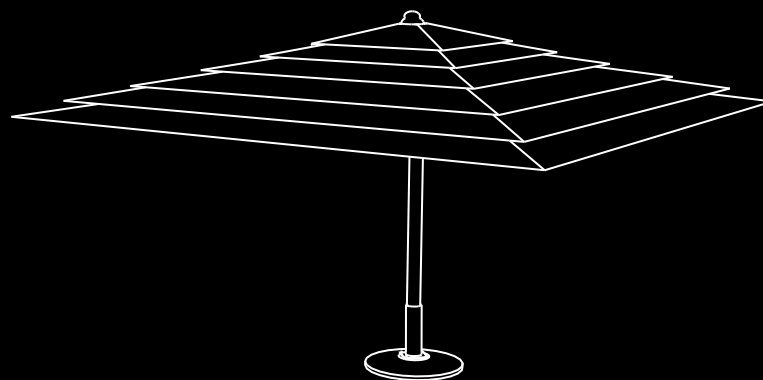

Standard



Optional



200x300 cm
250x350 cm
300x400 cm



300x300 cm
350x350 cm
400x400 cm
500x500 cm



Ø300
Ø350
Ø400





Big Friend

The Big Friend is a classic central beam umbrella with updated features like its 12 reinforced aluminum splints and telescopic pole that allows it to open up to dimensions of 50 m² under a single umbrella canopy. The telescopic system allows umbrella opening/closing without removing the chairs and tables underneath. Every rib is crafted from reinforced aluminum.

Big Friend è l'unico a poter raggiungere, con una singola capote, la dimensione di 50 m². La costruzione telescopica consente l'apertura e la chiusura senza dover spostare i tavoli e sedie, anche se vicini. La robustezza della costruzione viene assicurata dal possente palo centrale in acciaio, mentre le stecche sono realizzate in alluminio rinforzato.

Big Friend je suncobran sa centralnim stubom velikih razmjera. Teleskopski sistem u jakom čelicom stubu dozvoljava otvaranje suncobrana bez potrebe za pomjeranjem stolica i stolova u neposrednoj blizini. Velika površina do 50 m² je zaštićena od vremenskih uslova neuporedivo kvalitetnije i estetski privlačnije od tradicionalnih solucija sa mnoštvom malih reklamnih suncobrana. Sve letve su od pojačanog aluminija.

Standard



Optional



450x550 cm
500x600 cm
550x650 cm
600x700 cm



500x500 cm
550x550 cm
600x600 cm
650x650 cm
700x700 cm



Ø550 Ø600
Ø650 Ø700
Ø750 Ø800





Kite

The Kite is a tent-umbrella, a new concept that embodies the best qualities of a mountable tent but with the open/close easy of action of an umbrella. This even exempts it from the permits associated with permanent, gazebo and tent-like structures that need to be assembled and dismantled with each use. The sturdy construction, made entirely of zinc coated welded iron, allows the sheets to be closed using either Velcro or pulleys. This feature makes it the perfect solution for all seasons. These attributes, along with its patented electric opening mechanism and futuristic look, have earned the Kite recognition as the "future of outdoor umbrellas".

Kite è un tenso-ombrellone di nuova concezione che racchiude in sé le caratteristiche migliori di un gazebo combinate con l'apertura "a ombrellone" grazie alla quale la struttura è esentata dalla necessità di permessi comunali. La robustezza della costruzione, realizzata interamente in ferro zincato e plastificato, permette l'utilizzo di teli di chiusura, da applicare con velcro oppure con binari e carrelli scorrevoli, rendendo questo prodotto ideale per tutte le stagioni. L'apertura elettrica brevettata e l'aspetto avveniristico sono ulteriori punti di forza di questo modello, riconosciuto da molti come "il futuro dell'ombrellone".

Kite je inovacija u polju suncobrana, patent kojim se osobito ponosimo zbog nenadmašivih karakteristika čvrstoće i otpornosti na vjetar. Kite može biti korišćen i u najtežim vremenskim uslovima, od visokih planinskih predijela sa velikim količinama snježnih padavina do morskih plaža gdje bura i nevjere često znaju napraviti pravi pomet i uništiti tradicionalne suncobrane koji ne budu zatvoreni na vrijeme! Kite pravimo isključivo u kvadratnoj formi, do 6x6 metara veličine. Moderni izgled zajedno sa patentovanim električnim otvaranjem, daju sa pravom Kite-u nadimak "suncobran budućnosti".

Standard



Optional

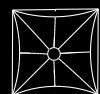

300x300 cm	350x350 cm
400x400 cm	450x450 cm
500x500 cm	600x600 cm





Ciak

Our Ciak model is an Edengarden exclusive developed specifically for cafés and restaurants that line the narrow city streets in historic city centers such as Florence. The Ciak takes full advantage of your outdoor space. It has the smallest lateral footprint but allows a vast area of space to be covered, the perfect solution for those who need to shelter long narrow spaces.

Ciak è un prodotto esclusivo EdenGarden, studiato appositamente per i bar e i ristoranti delle vie dei centri storici come quello fiorentino. Il minimo ingombro del palo laterale, unito alla possibilità di coprire larghe aree con poca profondità, lo rende ideale per chi necessita di coprire spazi poco profondi e larghi, sfruttando al massimo l'area sottostante.

Ciak je naš ekskluzivni model namjenjen za uske i dugačke prostore koji obično odlikuju ulice centara starih gradova. Ciak daje mogućnost punog korištenja Vašeg prostora. Uz najmanju moguću površinu zauzetu nosećim stubom pokriva širok prostor, nudeći perfektno rješenje za ugostiteljske platforme i bašte dubine do 2,5 metara.



Standard



Optional

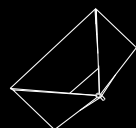

100x250 cm	125x250 cm	150x300 cm	125x350 cm
175x250 cm	150x400 cm	200x300 cm	225x350 cm
175x450 cm	175x350 cm	150x325 cm	200x400 cm
250x400 cm	200x500 cm	250x500 cm	



ARCO • TALENTO • TALENTO STEEL • MISTER

Ombrelloni a Palo Laterale
Side Post Patio Umbrellas
Bočni suncobrani



side

HOTEL
500

FIRENZE





The Arco is characterized by its departure from traditional portable joists. This model is an attractive refined solution that can cover large elegant spaces. Our expert craftsmen make the arch entirely from iroko wood and its lamellar construction ensures maximum reliability and durability. Every single component is designed to enhance its weather resistance, but without compromising its aesthetic features.

Arco è forse l'ombrellone della nostra collezione più apprezzato per le sue qualità estetiche. Il suo segno distintivo è la curvatura del robusto sostegno in legno iroko, realizzata esclusivamente per EdenGarden. Questo modello è adatto a chi desidera coprire, in modo raffinato ed attraente, aree in ambienti spaziosi e curati.

Arcov izvanredni dizajn proizilazi iz unikatnog nosećeg stuba izrađenog od iroko drveta, savijenog u luk u našim postrojenjima. Cijela konstrukcija dizajnirana je tako da osigura dugogodišnju estetiku i funkcionalnost, a uzdignuti ventil štiti od iznenadnih naleta vjetra. Za još bolju otpornost savjetujemo naš patent Split Solution, koji uz prefinjeni izgled daje "odušak" vjetru koji prolazi kroz 6 slojeva nepromočivog platna.



Standard



Optional

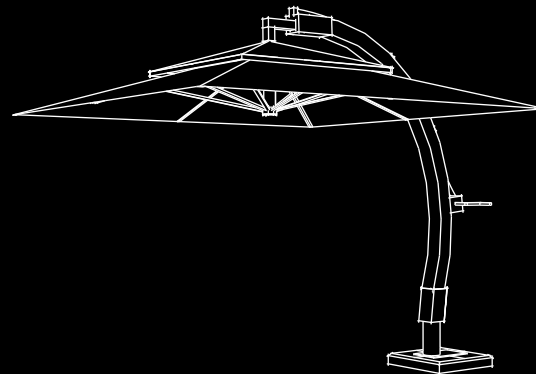

200x300 cm
250x350 cm
300x400 cm



300x300 cm
350x350 cm



Ø300
Ø350
Ø400



Talento

The Talento is a medium size umbrella with a lateral post. Thanks to its extreme versatility and ease of handling, it is suitable for both private and professional use. The vertical load bearing beam permits optimal usage of the area beneath, just as the possibility to rotate the base by 360° makes it possible to 'chase' the shade during the course of the day.

Talento è un ombrellone a palo laterale di dimensioni medie, adatto, grazie alle sua estrema versatilità e maneggevolezza, sia ad un uso privato che professionale. Il travetto portante verticale consente l'utilizzo ottimale dello spazio sottostante, così come la possibilità di rotazione di 360° della base permette di "inseguire" l'ombra nell'arco della giornata.

Talento je bočni suncobran srednje veličine. Zahvaljujući njegovoj pouzdanosti, lakoći korišćenja i prilagodljivosti, prigodan je kako za privatnu tako i profesionalnu upotrebu. Vertikalni bočni nosač omogućuje optimalno korišćenje oslobađajući prostor ispod suncobrana, a mogućnost rotiranja za 360 stepeni suncobrana olakšava "traganje" za sjenom tokom cijeloga dana!

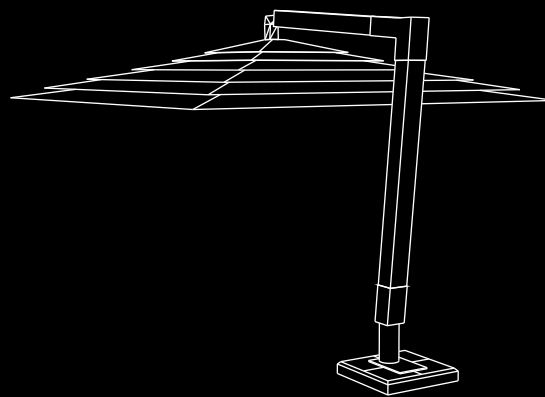

Standard



Optional



200x300 cm
250x350 cm
300x400 cm
350x450 cm



250x250 cm
300x300 cm
325x325 cm
350x350 cm
400x400 cm



Ø300
Ø350
Ø400
Ø450





Talento Steel

Talento Steel is an umbrella with a simple elegant design. The clean lines and 360° revolving design make it versatile and suitable for all environments. It is mostly requested for terraces and platforms, where the traditional concrete base would limit the useful ground space. The mirror polished stainless steel version is suitable for installation on luxury yachts and modern buildings.

Talento Steel per assicurare una grande facilità di adattamento alle esigenze di ombreggiatura di pedane esterne, terrazzi, giardini e tutti gli altri spazi inadatti all'ingombro di una base in cemento. Infatti, la possibilità di realizzare gli ancoraggi su disegno e su richiesta del cliente fa di questo ombrellone un complemento di arredo non invasivo, inserito nel contesto con naturalezza ed eleganza. Nella versione acciaio inossidabile Aisi 316 lucidato a specchio si propone come accessorio indispensabile per yacht di lusso e strutture di concezione moderna.

Talento Steel je suncobran sa čistim i jednostavnim dizajnom. Njegova minimalistička linija ga čini pogodnim za instaliranje u svaki prostor. Najčešća primjena Talento Steel modela je na terasama ugostiteljskih objekata i privatnih kuća, gdje bi standardna baza ometala u kretanju u ograničenom prostoru. Ovaj suncobran je razvijen i u Stainless Steel AISI 316 (ispolirani nehrđajući čelik) verziji, pa je pogodan i za instaliranje na velikim jahtama, pogotovo sa sistemom antivjetar Split Solution i inovativnim mikroizbušenim Soltis Air platnom.

Standard



Optional



200x300 cm
250x350 cm
300x400 cm
350x450 cm



250x250 cm
300x300 cm
325x325 cm
350x350 cm
400x400 cm



Ø300
Ø350
Ø400
Ø450

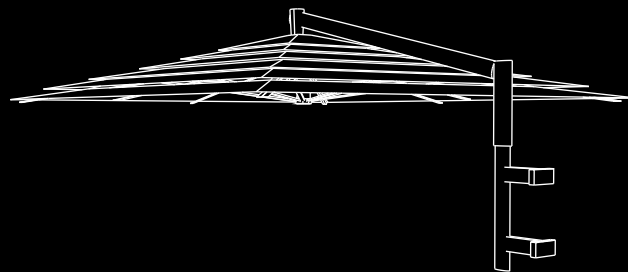



Mister

The Mister has a robust vertical 5.5x5.5 inch beam that can support large canopies and thus free space that would otherwise be occupied by a cement base. EdenGarden recommends Split Solution canopies for usage in windy areas. From this year, the Mister can also be crafted with a 360° rotating base.

Mister assicura, grazie al trave portante di 14 x 14 cm, una robustezza e affidabilità tali da poter sostenere capote di grandi dimensioni senza l'ingombro di una base sotto all'ombrellone. EdenGarden consiglia le capote Split Solution per l'uso in zone ventilate. Da quest'anno è disponibile anche la versione con il piede girevole di 360°.

Mister ima čvrsti bočni nosač 14 x 14 cm načinjen po izboru od afričkog iroko drveta ili čelika cinčanog i plastificiranog u željenoj boji. Zahvaljujući jakoj konstrukciji može nositi suncobrane do 5 x 5 metara veličine, oslobađajući u potpunosti natkriveni prostor. Od ove godine Mister može imati kao dodatak i 360° rotirajuću stopu.

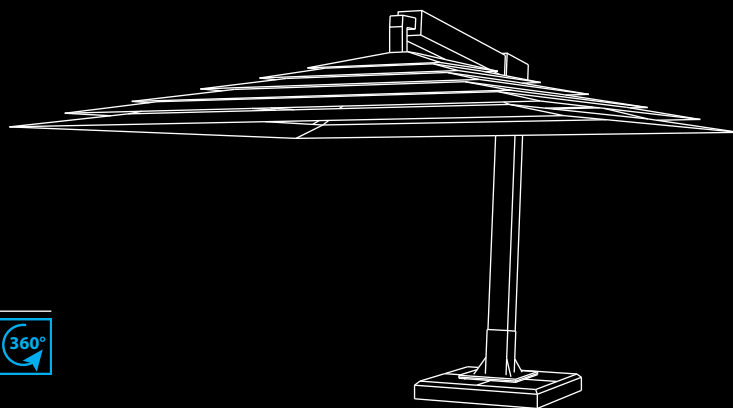

Standard



Optional



500x400 cm
550x450 cm



400x400 cm
500x500 cm



Ø500
Ø600





GEMELLI LATERALE • GEMELLI CENTRALE • GEMELLI STEEL • COLLAGE

Ombrelloni **Multipli**
Multiple Canopy Patio Umbrellas
Višestruki suncobrani



multa



Gemelli Laterale

With its two inward leaning canopies that join on a central or lateral support the Gemelli creates a large rectangular shadow that can cover a space of up to 16.5 x 33 ft. The Gemelli can also connect with other modular systems, such as the Mister and the Collage, to cover even irregular spaces. The lateral support version is ideal for covering large tables or buffets.

Gemelli, con le sue due capote appoggiate su un sostegno centrale o laterale crea un'ombra rettangolare che arriva fino ai 5 x 10 metri e si presta alla combinazione modulare con modelli quali Mister e Collage per coprire grandi spazi anche irregolari. Il sostegno laterale si favorisce l'inserimento di grandi tavolate o buffet.

Na velikom čvrstom nosaču načinjenom od iroko drveta ili cinčanog i po želji farbanog željeznog profila, dvije horizontalne ruke nose svaka po jedan veliki suncobran, za ukupnu velicinu do 5x10m. Nosač može, po izboru biti centralni ili bočni. Sa bočnim nosačem cjelokupan prostor ispod suncobrana je iskoristiv za stolove i posebno je pogodan za velike gozbene prigodbe i katering servise.

Standard



Optional

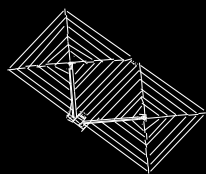

250x500 cm
300x600 cm
325x650 cm
350x700 cm
400x800 cm
450x900 cm
500x1000 cm

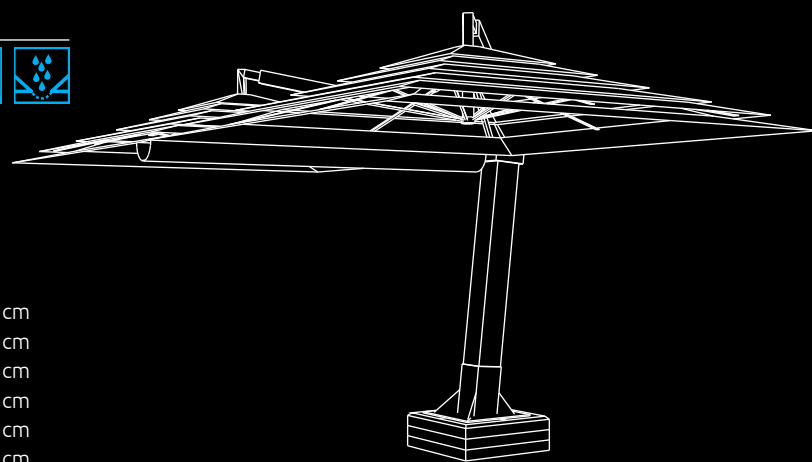



gemelli Gemelli Centrale

The central post solution leaves the surrounding zone free to access and a concrete base can be used as an elegant table or a sitting bench.

La soluzione con il palo centrale lascia libera la zona perimetrale per l'accesso alla zona aperta e la base in cemento puo' essere usata come tavolino oppure panca per posti a sedere aggiuntivi.

Sa centralnim nosačem prilaz suncobranu je slobodan sa svake strane a cementna baza može elegantno biti iskorišćena kao stolić ili pokrivena klupom za sjedenje.

Standard



Optional

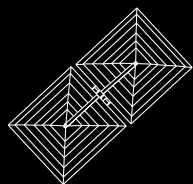

- 250x500 cm
- 300x600 cm
- 325x650 cm
- 350x700 cm
- 400x800 cm
- 450x900 cm
- 500x1000 cm

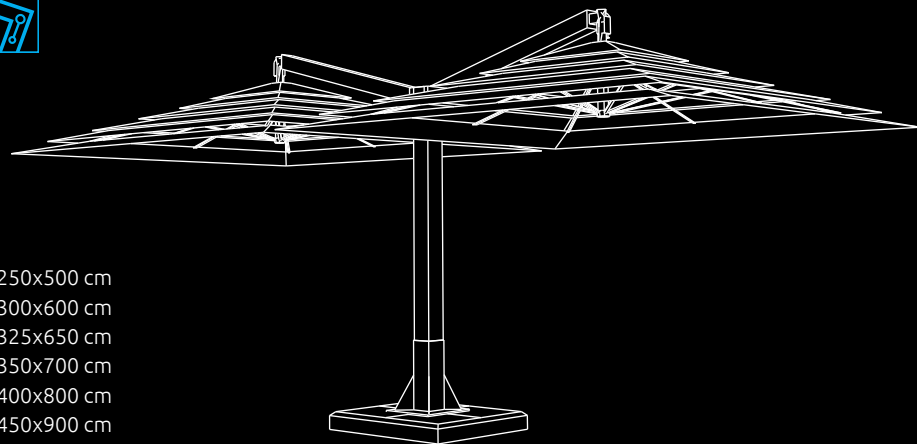



Gemelli Steel

Gemelli Steel is part of the steel line and represents an evolution of the Gemelli Patio Umbrella. The two umbrellas can be oriented and moved when closed to 'follow' the shade during the day. The entire structure is made of thick galvanized steel and painted in the selected color. The Gemelli Steel has an innovative but simple design. The finely polished AISI 316 stainless steel version of this double patio umbrella is suitable for most exclusive modern environments and luxury yachts.

Gemelli Steel fa parte della linea Steel, e rappresenta l'evoluzione dell'ombrellone Gemelli. A differenza di questo, i due ombrelli possono essere orientati e spostati dalla zona di ingombro una volta chiusi, oppure "inseguire" l'ombra durante il giorno. L'intera struttura è fatta di acciaio di forte spessore, interamente zincato e verniciato a forno. Gemelli steel è caratterizzata da una linea innovativa, ma allo stesso tempo semplice, adatta ad inserirsi in tutti gli ambienti outdoor, e nella versione acciaio inossidabile AISI 316 stainless ha trovato posto come accessorio di pregio per gli yachts di lusso.

Gemelli Steel je dio Steel linije i predstavlja evoluciju Duplog Suncobrana Gemelli. Na ovom modelu 2 suncobrana, koja se mogu rotirati za 180 stepeni i ukloniti sa prohodnog prostora kada se ne koriste. Cijela konstrukcija karakterizirana je inovativnim, a u isto vrijeme jednostavnim dizajnom. I ovaj suncobran, kao i svi suncobrani Steel linije, može se izraditi u Stainless Steel AISI 316 verziji (ispolirani nehrđajući čelik), koji osigurava vječnost i perfekciju u svim uslovima i savršeno se uklapa kako na moderne i ekskluzivne građevine tako i na velike i luksuzne jahte!

Standard



Optional

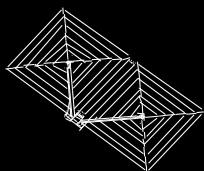

250x500 cm	2x Ø200
300x600 cm	2x Ø250
325x650 cm	2x Ø300
350x700 cm	2x Ø350

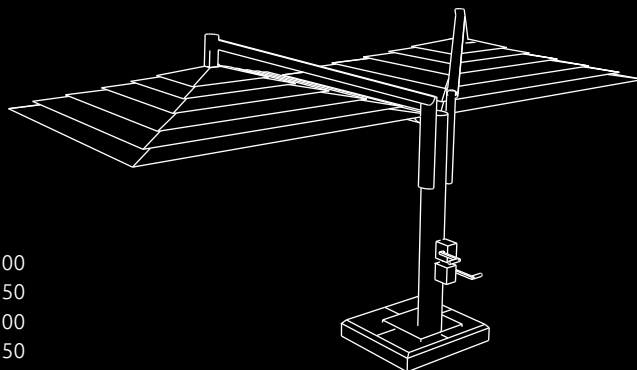



Collage

The Collage has four square canopies that each expand to 16.5ft and all together can cover an area of up to 1,089 square feet. The structure commands attention with the finest most sought after trims on the market today. The Collage is ideal for covering large square spaces and designed to prevent rainwater from seeping between the canopies by use of a special drip-guard linkage system.

Collage unisce quattro capote di dimensioni fino a 5 x 5 metri, con le quali arriva fino a 100 metri quadrati di superficie. L'aspetto imponente e le ricercate rifiniture fanno di questo ombrellone il prodotto ideale per chi necessita di coprire grandi spazi quadrati, chiudibili all'occorrenza con teli ombra laterali e protetti dalla pioggia anche nelle intercapedini tra le capote grazie alle gronde di collegamento.

Veliki Suncobran Collage ujedinjuje 4 pojedinačna suncobrana, veličine do 5 x 5 metara, u jedan ogromni suncobran na centralnom nosećem stubu, ukupne veličine do 10 x 10 metara. Njegova impozantna pojava i sofisticirani detalji čine od ovog suncobrana savršen proizvod za one koji žele pokriti velike kvadratne prostore, zaštićene od sunca i kiše, zahvaljujući i sistemu povezivanja pojedinačnih suncobrana putem platnenih oluka.

Standard



Optional

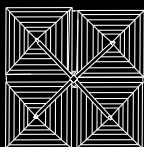

500x500 cm	600x600 cm
650x650 cm	700x700 cm
800x800 cm	900x900 cm
1000x1000 cm	

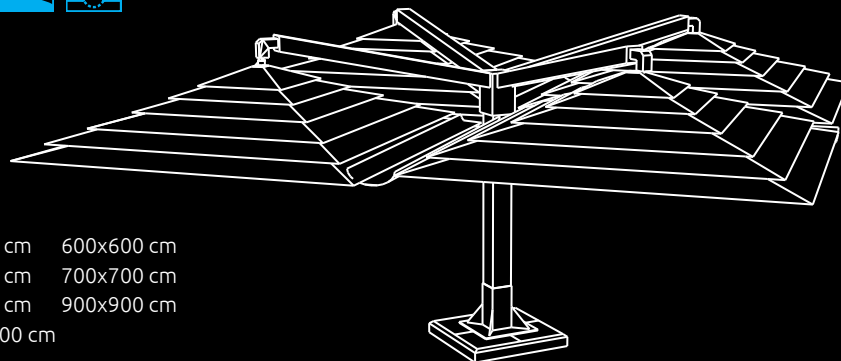

Fabrics Choice

The fabric is the most important part of any umbrella. This is why at EdenGarden we offer only the best outdoor fabrics available on the market today.

Il tessuto è la parte più importante di ogni ombrellone! E' per questo che noi in EdenGarden offriamo solo I migliori tessuti per esterni.

Platno je najbitniji dio svakog suncobrana. Zato EdenGarden nudi samo najbolja platna za vanjsku upotrebu.

ACRYLIC 100%, 300gr/sqm, made in Spain



Acrylic fabric (100%) is non-decomposable and anti bacterial with a 10 year warranty. The Teflon-treated fabric is water and dirt resistant.

Tessuto acrilico 100% imputrescibile e antibatterico, garantito 10 anni. Trattato al Teflon, idrorepellente, anti-macchia.

Akrilno platno 100% anti-trulež i anti bakterijsko sa 10 godina garancije. Teflon premaz za vodootpornost i otpornost na prljavštinu.

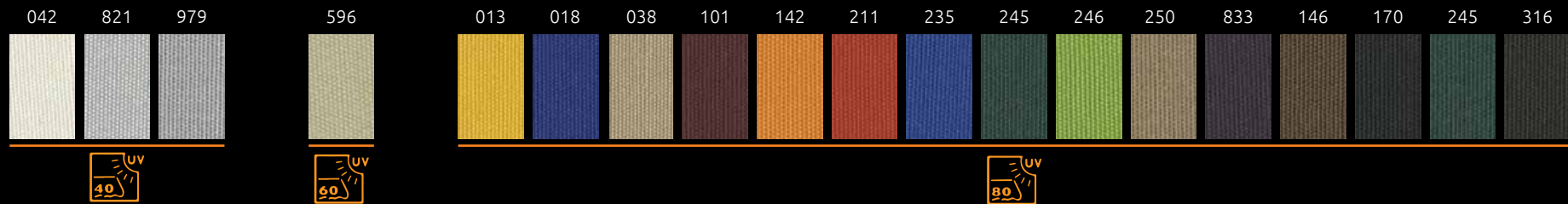

PVC Precontraint, 590gr/sqm, made in France

100% waterproof, pre-tensioned high dimensional stability, UV resistant, fireproof (2nd class), easy to maintain, durable and tear resistant.

100% impermeabile, pretensionato, stabilità dimensionale elevata, UV resistente, ignifugo classe 2, facile da mantenere, lunga durata, resistenza allo strappo.

100% nepromociv, pre-tensioniran, visoka dimenzionalna stabilnost, nezapaljiv (druga klasa), lako održavanje, dugotrajan, otporan na cijepanje.

MICRO AIRED SOLTIS, 400gr/sqm

Outward visibility, micro-ventilated, light, durable and 100% recyclable.

Visibilità verso l'esterno, micro-ventilato, leggero, duraturo, 100% riciclabile.

Providan, mikro ventilisan, lagan, dugotrajan, 100% reciklaza.



Finishing

Bordino / Ribbon / Obrubna traka

The final customization touch is the ribbon color, which is available in all listed fabric colors.

Il tocco finale è il colore del bordino. Sono disponibili bordini in tutti i colori dei tessuti.

Zadnji dodir personalizacije je boja obrubne trake. Dostupna je u svim bojama platna.

Parti in metallo / Metal parts / Metalni dijelovi:

All metal parts are zinc plated and furnace painted in the following RAL colors (choice):

I componenti in metallo sono tutti zincati e platificati in un colore RAL a scelta tra:

Svi metalni dijelovi su cincani i plastificirani u RAL boji po izboru:

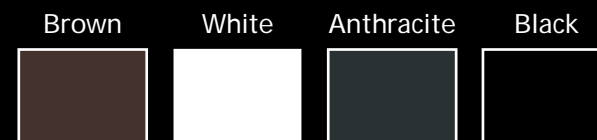

Stecche / Ribs/ Letve (20x40x2mm)

For all umbrellas up to 4x4 m with a Raised Valve the ribs can be wooden or aluminum. All larger umbrellas and Split Solution umbrellas have ribs that are made only of aluminum. The available colors are:

Tutte le stecche degli ombrelloni a valvola rialzata fino alla misura 4x4m possono essere realizzati in legno frassino oppure alluminio. Gli ombrelloni più grandi e tutti gli ombrelloni Split Solution si realizzano esclusivamente con le stecche in alluminio.

Svi suncobrani uzdignutog ventila do 4x4m veličine mogu biti sa aluminijskim ili drvenim letvama. Svi veći suncobrani i svi Split Solution suncobrani rade se isključivo od aluminijskih letvi. Boje se mogu birati između:

*Tutti gli altri colori sono disponibili con supplemento sul prezzo.
All other colors are available with an extra charge.
Sve ostale boje su dostupne sa dodatnom naplatom.*

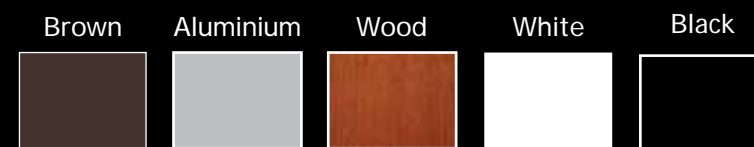

Umbrella Type	Dimension	Pole Material choice			
		Iroko	Iron	Stainless Steel	Aluminum
Fiesole, Ciak	Ø 50–60mm		✓		✓
BigFriend, Kite	Ø 13cm		✓	✓	
Talento	9x9cm	✓	✓	✓	
Arco	9x9cm	✓			
Talento Steel	Ø 60 – 70mm		✓	✓	
Gemelli Steel	Ø 13cm or 14x14cm		✓	✓	
Mister, Gemelli, Collage	14x14cm	✓	✓		

Extras

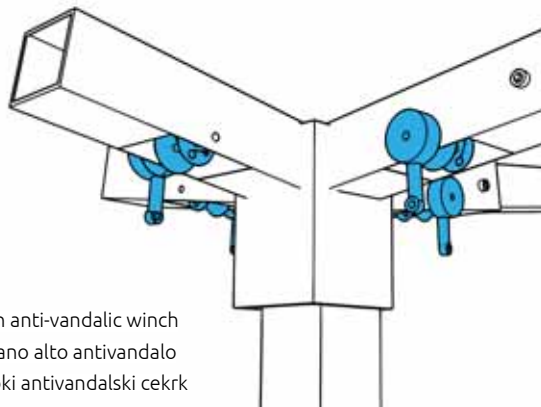

High anti-vandalic winch
Argano alto antivandalo
Visoki antivandalski cekrk

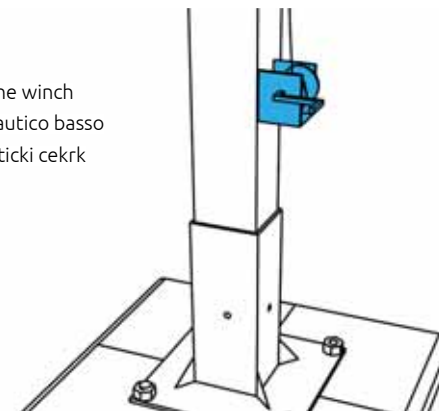

Low marine winch
Argano nautico basso
Donji nauticki cekrk

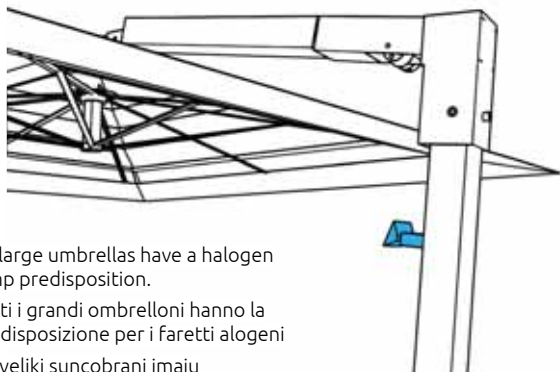

All large umbrellas have a halogen lamp predisposition.
Tutti i grandi ombrelloni hanno la predisposizione per i faretti alogeni
Svi veliki suncobrani imaju predispoziciju za halogenu rasvjetu.

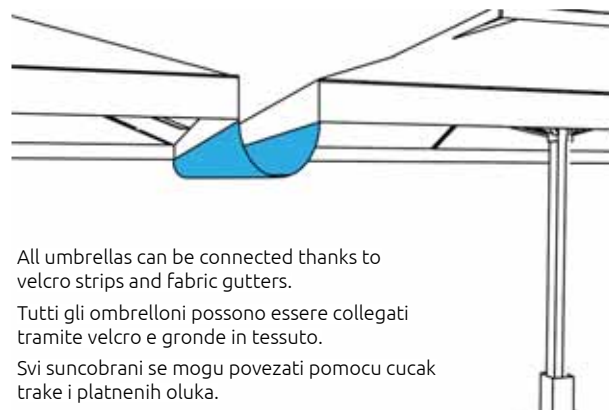

All umbrellas can be connected thanks to velcro strips and fabric gutters.
Tutti gli ombrelloni possono essere collegati tramite velcro e gronde in tessuto.
Svi suncobrani se mogu povezati pomocu cucak trake i platnenih oluka.

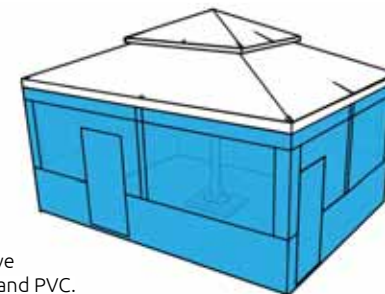

All umbrellas can have side panels in fabric and PVC.
Tutti gli ombrelloni possiamo essere dotati chiusure laterali in tessuto e PVC.
Na sve suncobrane mozemo montirati bocne panele od platna ili od PVC-a.



Iroko wood table available for side post umbrellas.
Tavolino in legno iroko disponibile per ombrelloni a palo laterale.
Stolic od iroko drveta za suncobrane sa bocnim nosacem.

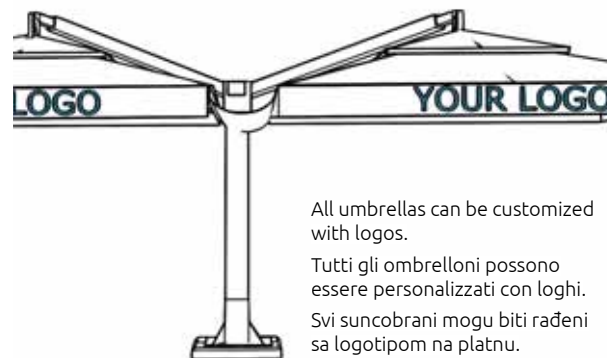

All umbrellas can be customized with logos.
Tutti gli ombrelloni possono essere personalizzati con loghi.
Svi suncobrani mogu biti radeni sa logotipom na platnu.



All Split Solution umbrellas can be made with double fabric.
Tutti gli ombrelloni Split Solution si possono fare con tessuto doppio.
Svi Split Solution suncobrani se mogu raditi sa duplim platnom.

Weights - Basi - Utezi

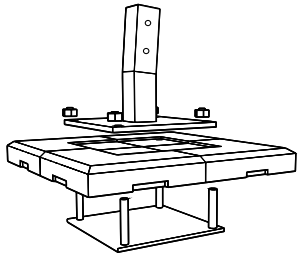

Large concrete base
Grande base in cemento
Velika cementna baza
(250-500-750 kg)

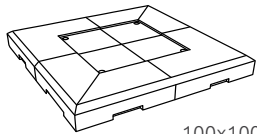

100x100x12 cm

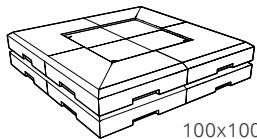

100x100x24 cm

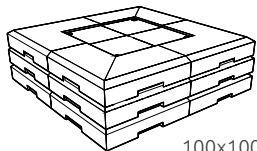

100x100x36 cm

Round concrete base
Base tonda in cemento
Okrugla cementna baza
(Fiesole & Ciak)
(50-70kg)

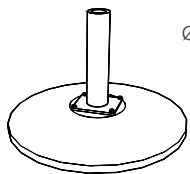

Ø60 cm

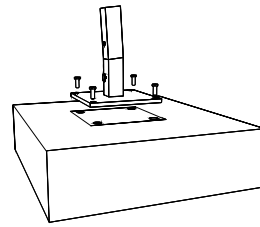

Inground bracket
Contropiastra da interrare
Kontraploca za betoniranje

Piccolo - Small - Mala

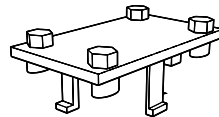

15x30 cm

Grande - Large - Velika

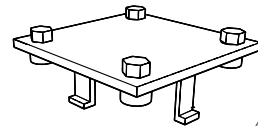

46x46 cm

Wall Bracket
Staffa a muro
Zidni anker
(Talento Steel & Gemelli Steel)

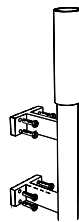

Size on request
Grandezza su richiesta
Mjera po zahtjevu

Metal frame for air shipping
(weights not included)
Telaio per spedizione aerea
(pesi non inclusi)
Metalni kostur za avioprevoz
(bez utega)

Small - Piccolo - Mala

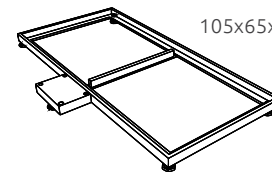

105x65x10 cm

Large - Grande - Velika

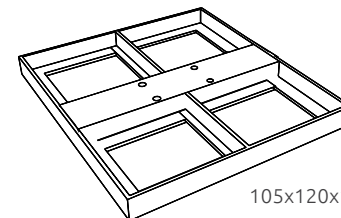

105x120x10 cm

Metal plate (60kg)
Base in metallo (60kg)
Metalna baza (60kg)
(Fiesole & Ciak)

Small - Piccolo - Mala

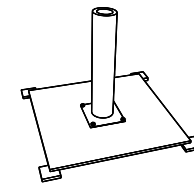

50x70 cm

Large - Grande - Velika

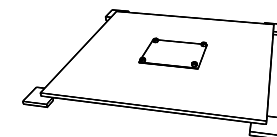

Size on request - Grandezza su richiesta
- Mjera po zahtjevu

Package

FIESOLE	1 package + base				Component
Umbrella size (in meters)	2x3; 3x3; 3Ø ; 3,5 Ø	2,5x3,5; 3,5x3,5; 3x4; 4Ø	4x4	5x5	
Package (in cm)	45 Ø x 240	45 Ø x 260	45 Ø x 280	45 Ø x 355cm	canopy
Weight with package (in kg)	40	45	55	70	
BIG FRIEND	2 packages + base				
Umbrella size (in meters)	4,5x5,5; 5x5; 5Ø ; 5,5Ø	5x6; 6x6m, 6Ø, 7Ø	6x7; 7x7;	8x6	
Package (in cm)	45 Øx410	45 Øx450	45 Øx500	45 Øx520	canopy
Package (in cm)	50x50x60cm	50x50x60	50x50x60	50x50x60	lower junction
Weight with package (in kg)	110	130	150	160	
KITE	3 packages + base				
Umbrella size (in meters)	3x3; 3,5x3,5	4x4; 4,5x4,5	5x5	5,5x5,5; 6x6	
Package (in cm)	50x50x300cm	50x50x330	50x50x360	50x50x400	structure
Package (in cm)	50x50x60	50x50x60	50x50x60	50x50x60	lower junction
Package (in cm)	50x40x100	50x40x100	50x40x100	50x40x100	fabric (separated)
Weight with package (in kg)	160	180	200	220	
CIAK	1 package + base				
Umbrella size (in meters)	SIZE x 250	SIZE x 300	SIZE x 400	SIZE x 500	
Package (in cm)	45 Ø x 240	45 Ø x 260	45 Ø x 280	45 Ø x 355cm	canopy
Weight with package (in kg)	40	45	55	70	
ARCO	3 packages + base				
Umbrella size (in meters)	2x3, 3 Ø	3x3, 2,5x3,5, 3,5Ø	3,5x3,5, 3x4, 4Ø	4x4	
Package (in cm)	45 Øx200cm	45 Øx220	45 Øx250	45 Øx300	canopy
Package (in cm)	15x400x150	15x400x150	15x400x150	15x400x150	arch
Package (in cm)	50x50x60	50x50x60	50x50x60	50x50x60	lower junction
Weight with package (in kg)	90	95	100	110	
TALENTO	3 packages + base				
Umbrella size (in meters)	2x3, 3 Ø	3x3, 2,5x3,5, 3,5Ø	3,5x3,5, 3x4, 4Ø	4x4 , 3,5x4,5	
Package (in cm)	45 Øx200cm	45 Øx220	45 Øx250	45 Øx300	canopy
Package (in cm)	15x25x250	15x25x250	15x25x250	15x25x250	poles
Package (in cm)	50x50x60	50x50x60	50x50x60	50x50x60	lower junction and L junction
Weight with package (in kg)	90	95	100	110	

TALENTO STEEL	3 packages + base or 2 packages (wall anchor option)				Componente
Umbrella size (in meters)	2x3, 3 Ø	3x3, 2,5x3,5, 3,5Ø	3,5x3,5, 3x4, 4Ø	4x4, 3,5x4,5	
Package (in cm)	45 Ø x200cm	45 Ø x220	45 Ø x250	45 Ø x300	canopy
Package (in cm)	15x30x180	15x30x180	15x30x180	15x30x180	vertical pole (if needed)
Package (in cm)	10x700x200	10x700x200	10x700x200	10x700x200	Horizontal pole
Weight with package (in kg)	75	80	85	110	
MISTER	5 packages + base				
Umbrella size (in meters)	4x4; 5Ø	4x5	5x5; 4,5x5,5; 6Ø		
Package (in cm)	45 Ø x270cm	45 Ø x330	45 Ø x390		umbrella
Package (in cm)	10x10x200	10x10x200	10x10x250		
Package (in cm)	15x15x250	15x15x250	15x15x250		vertical pole
Package (in cm)	50x50x80	50x50x80	50x50x80		lower junction and L junction
Weight with package (in kg)	135	145	160		
GEMELLI CENTRAL & SIDE POST	6 packages + base				
Umbrella size (in meters)	2,5x5; 3x6	3,25x6,5; 3,5x7	4x8	4,5x9; 5x10	
2 x Package (in cm)	45 Ø x250cm	45 Ø x280	45 Ø x330	45 Ø x380	umbrella
Package (in cm)	15x25x250	15x25x250	15x25x300	15x25x360	horizontal poles
Package (in cm)	15x15x250	15x15x250	15x15x270	15x15x300	vertical pole
Package (in cm)	50x50x80	50x50x80	50x50x80	50x50x80	lower junction
Package (in cm)	50x50x80	50x50x80	50x50x80	50x50x80	upper junction
Weight with package (in kg)	190	210	220	250	
GEMELLI STEEL	4 packages + base				
Umbrella size (in meters)	250x500; 2xØ200; 2x Ø250	3,25x6,5; 3,5x7	4x8		
2 x Package (in cm)	45 Ø x220cm	45 Ø x250	45 Ø x330		umbrella
Package (in cm)	10x70x220	10x70x250	10x70x300		horizontal poles (L shaped)
Package (in cm)	15x15x200	15x15x200	15x15x220		vertical pole
Weight with package (in kg)	175	195	220		
COLLAGE	9 packages + base				
Umbrella size (in meters)	5x5,6x6	7x7	8x8	9x9, 10x10	
4 x Package (in cm)	45 Ø x250cm	45 Ø x280	45 Ø x330	45 Ø x380	canopy
2 x Package (in cm)	15x25x250	15x25x250	15x25x300	15x25x360	horizontal poles
Package (in cm)	15x15x250	15x15x250	15x15x270	15x15x300	vertical poles
Package (in cm)	50x50x80	50x50x80	50x50x80	50x50x80	upper junction
Package (in cm)	50x50x80	50x50x80	50x50x80	50x50x80	lower junction
Weight with package (in kg)	350	375	420	500	



AG VEBO d.o.o., Tržaška cesta 133, 1000 Ljubljana SLOVENIJA